

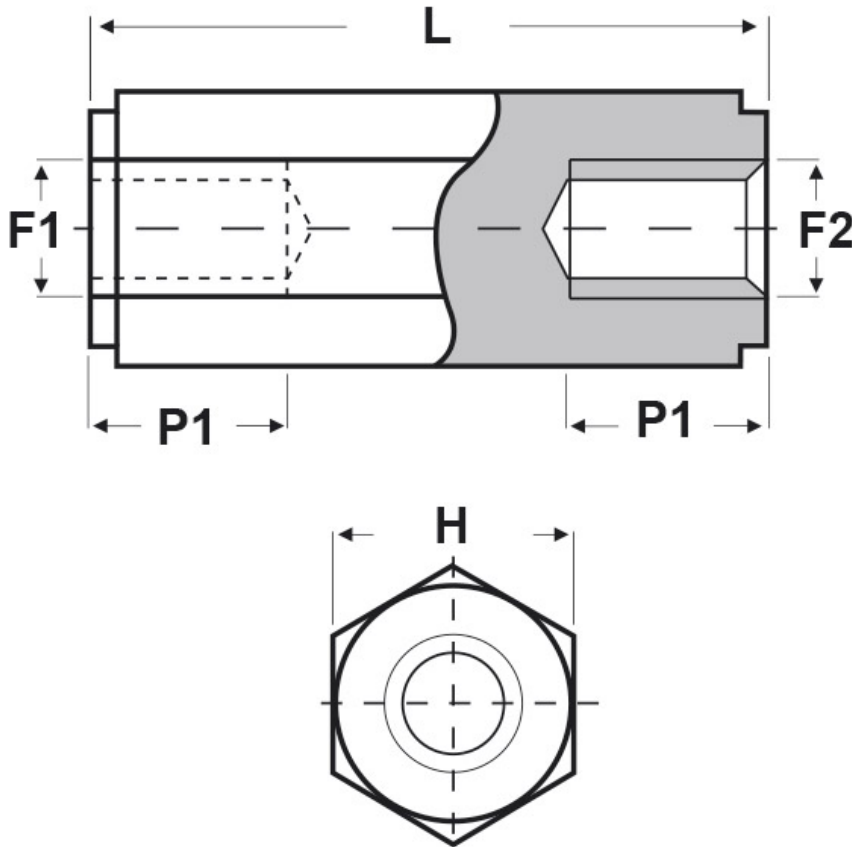

SCHEMA ARTICOLO

Articolo: FF09 H 2550 17 PA6-RV NERI - Codice EZ: request the code from our sales office 06/12/2025



The drawing is indicative and the proportions may not correspond to the table or real dimensions.

ITEM	thread pitch F1	thread value F1	thread pitch F2	thread value F2	H mm	L mm	P1 mm
FF09 H 2550 17 PA6-RV NERI	Metric	2,5	Metric	2,5	5	17	8

Material: polyamide 6 reinforced with glass fiber (25% -30%).

Use temperature: -30°C / +110°C

Color: black.

Tutte le informazioni e i dati riportati sono indicativi e possono essere soggetti a variazioni senza preavviso

ELEKTROZUBEHÖR SPA

Sede:
Via F.lli Bronzetti, 24
20129 Milano (Italy)

Tel.: +39 02 701471
C.F. e P. IVA: 00729140152
Capitale Sociale: € 260.000

Centro logistico:
Via Cadorna, 66/A
20055 Vimodrone MI

Registro imprese: n° 92394 Tribunale di Milano
R.E.A.: 460657 - INTRASTAT: IT 00729140152
Posizione Import: MI 007993

